

Air through perfection

Swirl diffuser

ST

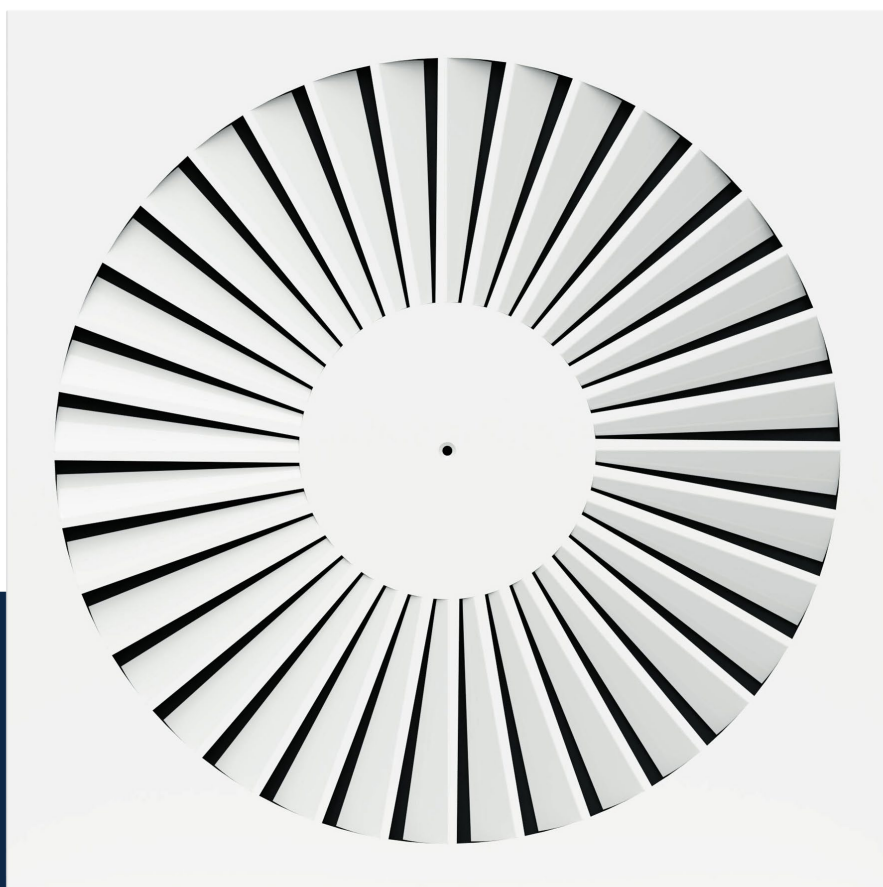

ACP
Swirl diffusers

Swirl diffuser ST

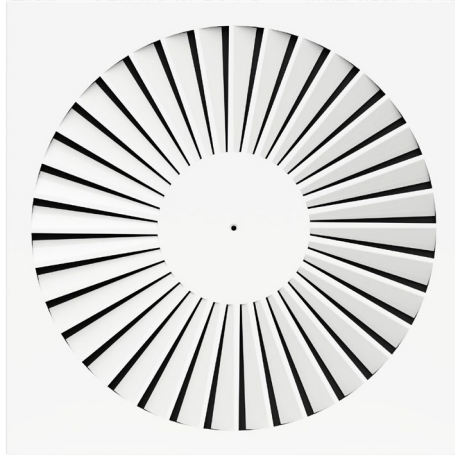

Description

ST is a square swirl diffuser used for introducing or evacuating the air.

The diffuser is recommended for rooms up to 4m high.

The design of the blades, their radial arrangement and the swirl action determine a high level of induction rate.

The diffuser can be used for installations with constant or variable air flow.

Technical specifications

Characteristics

The diffuser blades are fixed and arranged radially at the front plate.

Air induction occurs rapidly due to the swirl action, resulting in a rapid change of temperature.

The diffuser has the external dimensions 595x595 mm.

Diffuser installation is easy.

The product is delivered with the following elements: mounting bracket, fixing screw, screw cover cap and sealing gasket.

Materials

The diffuser is made of galvanized steel sheet and is electrostatic field painted in glossy white RAL 9016. Other RAL colours are available on request.

Technical drawing

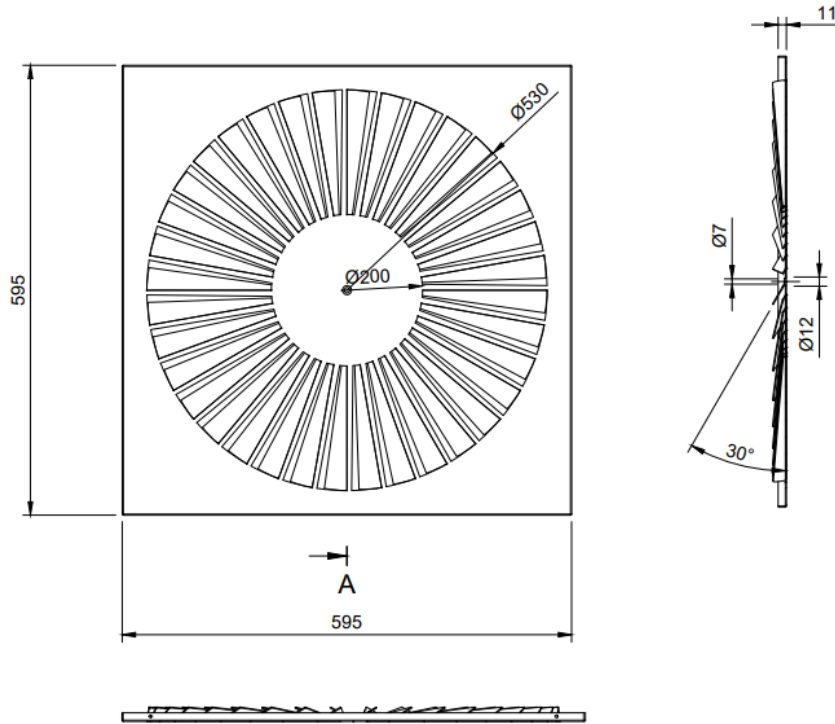

Product specifications

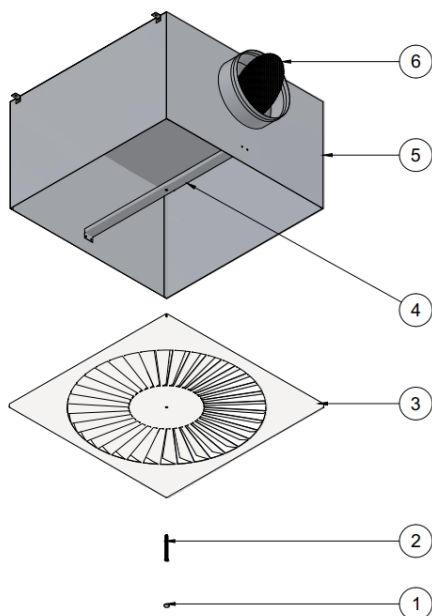

- 1 - Masking cap
- 2 - Fixing screw
- 3 - ST diffuser
- 4 - Bracket (mounting crossbar)
- 5 - Plenum box (optional)
- 6 - Perforated damper (optional)

Accessories

The diffuser can be delivered with a connecting plenum to the circular duct, with horizontal or vertical connection. The plenum is provided with suspension elements (lugs) and bead roll on the spigot, for easy fixing of the flexible duct. Optionally, a perforated damper can be mounted on the plenum connection to balance the air flow.

Adapter (plenum box)

Horizontal connection
(side/lateral exit)

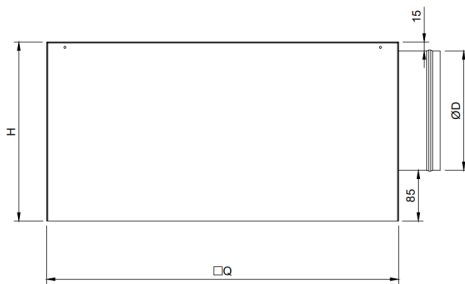

Vertical connection
(opposite exit)

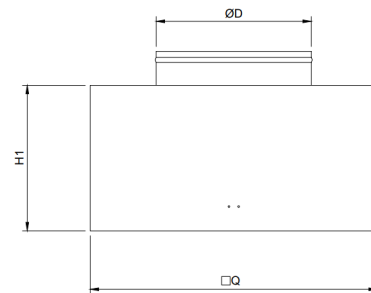

□Q: 590 x 590 mm – for mounting in 600x600 mm T-bar ceiling and suspended
565 x 565 mm – for continuous ceiling mounting
H – depending on ØD
H1 – on request

The adapter is made of Z140 galvanized steel sheet and has 4 suspension lugs.

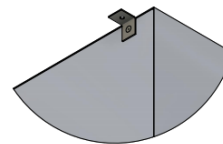
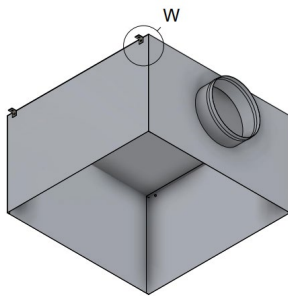

W - Suspension lug

On request, the plenum can be insulated with 6 mm thick elastomeric rubber.

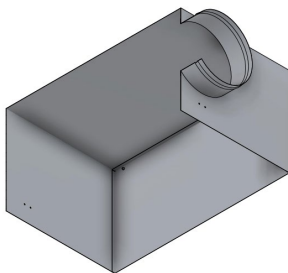

AN - Uninsulated adapter

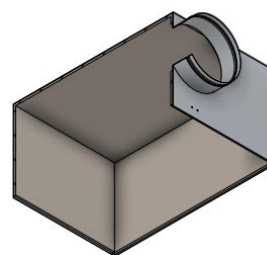

AIZ - Insulated adapter

Perforated damper

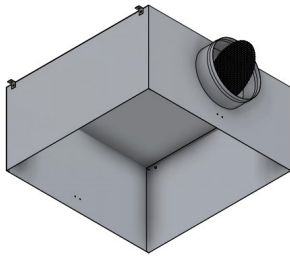

Position 0°

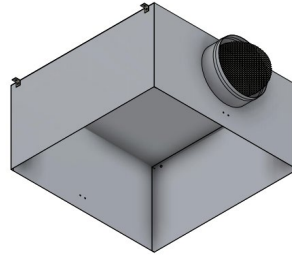

Position 45°

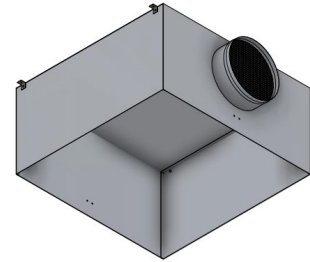

Position 90°

The perforated damper is mounted on the adapter spigot and has the role of balancing the air flow.

Functional parameters

Air flow	Dimension [mm]	595 x 595
(m ³ /h)	Ak [m ²]	0.0295
100	ΔPt [Pa]	1.0
	X [m]	0.9
	NR [dB(A)]	5.0
250	ΔPt [Pa]	5.0
	X [m]	2.3
	NR [dB(A)]	12.0
350	ΔPt [Pa]	10.0
	X [m]	3.2
	NR [dB(A)]	24.0
450	ΔPt [Pa]	17.0
	X [m]	4.0
	NR [dB(A)]	32.0
600	ΔPt [Pa]	30.0
	X [m]	5.2
	NR [dB(A)]	41.0
800	ΔPt [Pa]	54.0
	X [m]	6.7
	NR [dB(A)]	50.0

Note

The above values are given for a temperature difference of -6K and for horizontal connection to the duct.

The legend

Ak [m²] - The free surface

ΔPt [Pa] - Pressure loss

X [m] - The length of the air jet at a speed of 0.25 m/s

NR [dB (A)] - Noise level without room attenuation

Installation

The diffuser can be mounted in 600 x 600 mm T-bar false ceiling, continuous ceiling or suspended.

The fixing of the plenum diffuser is done by using a central screw screwed into the mounting bracket, positioned inside of the plenum box.

Installation in T-bar suspended ceiling

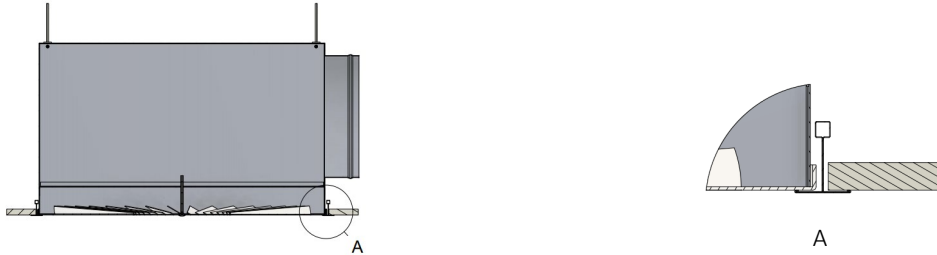

Installation in continuous ceiling

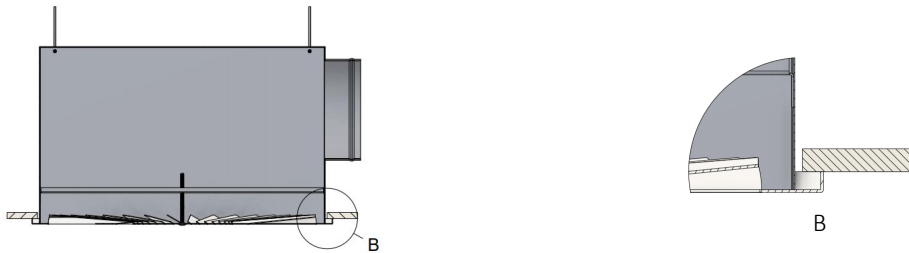

Suspended in the ceiling

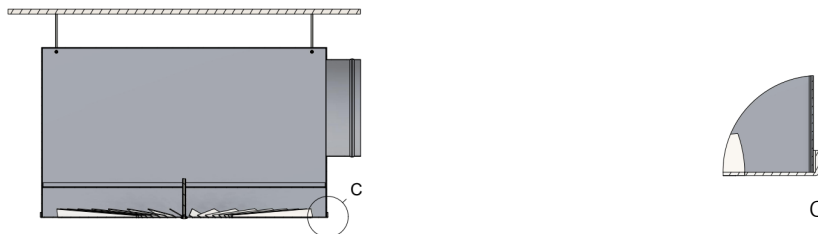

Order code

Example on how to place an order

Type	Dimensions	Accessories	Finish
ST	595 x 595 mm		
AIZ - Insulated adapter			
AN - Uninsulated adapter			
Perforated damper (plenum box)			
RAL 9016			
RAL.. - Other RAL colors on request			