

Air through perfection

Swirl diffuser

SW-R

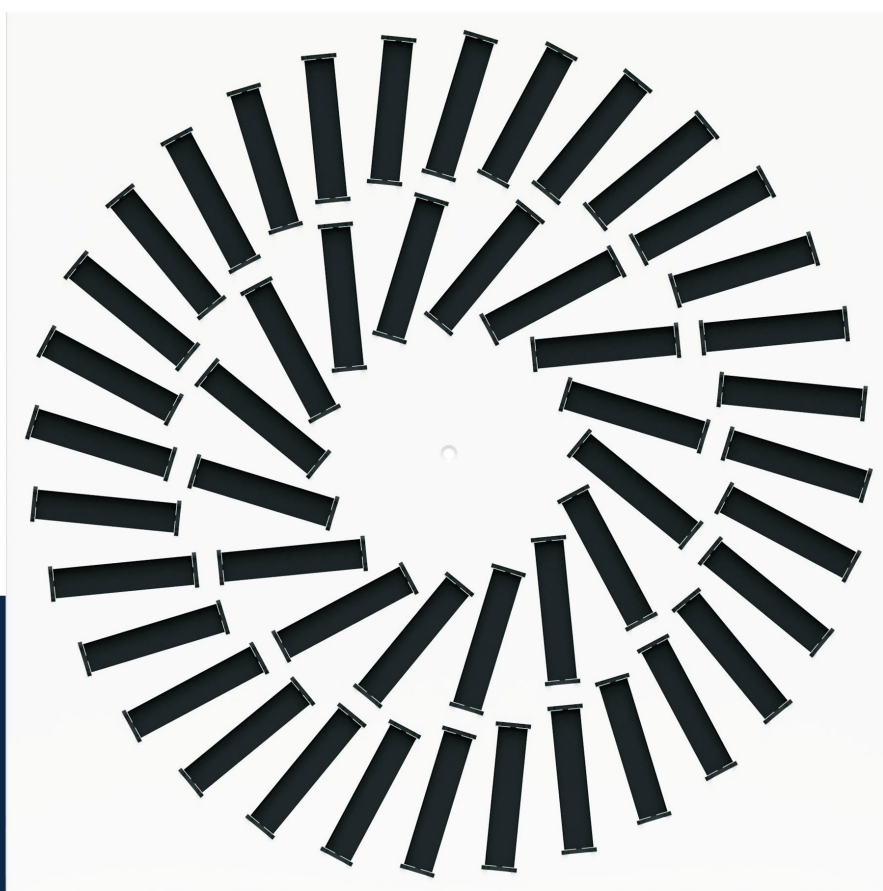

ACP
Swirl diffusers

Swirl diffuser SW-R

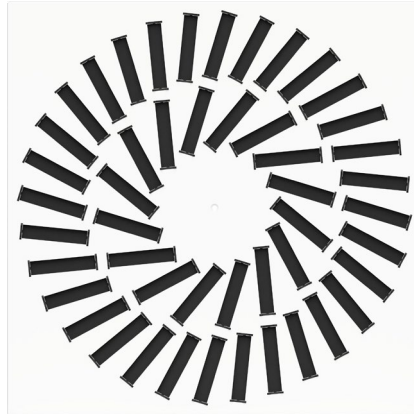

Description

SW-R is a swirl diffuser with a square front plate, used to introduce or exhaust air.

The diffuser is recommended for rooms with heights between 2.6 and 4 m.

The design of the blades, their radial arrangement and the swirl action determine a high level of induction rate.

The diffuser can be used for installations with constant or variable air flow.

Technical specifications

Characteristics

The diffuser has external dimensions 595x595 mm and can be made with 24 or 48 slots.

The diffuser is provided with individually adjustable black aluminum blades.

Air induction occurs rapidly due to the swirl action, resulting in a rapid change in temperature.

The product is delivered with the following elements: mounting bracket, fixing screw, screw cover cap and sealing gasket.

Materials

The product is made of galvanized steel sheet and is electrostatic field painted in glossy white RAL9016.

Other RAL colours are available on request.

The diffuser blades are made of black anodized aluminum.

Technical drawing

SW-R-24

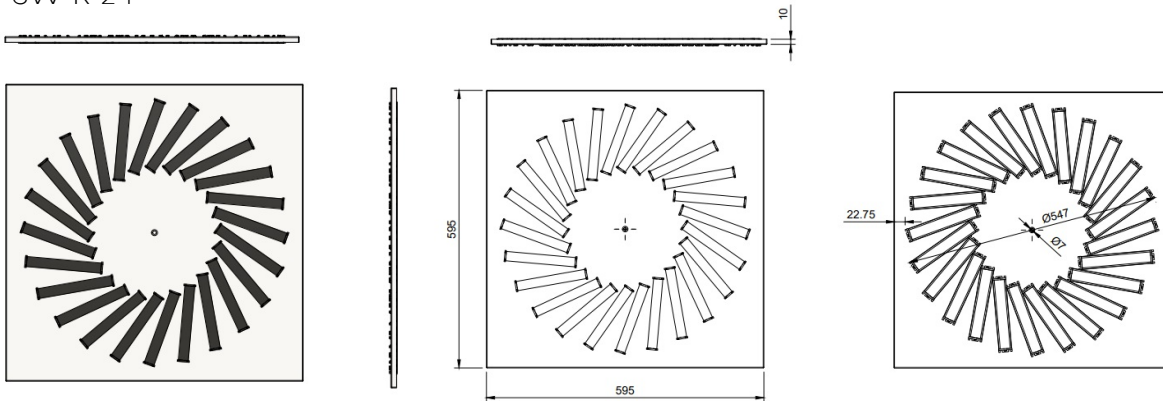

SW-R-48

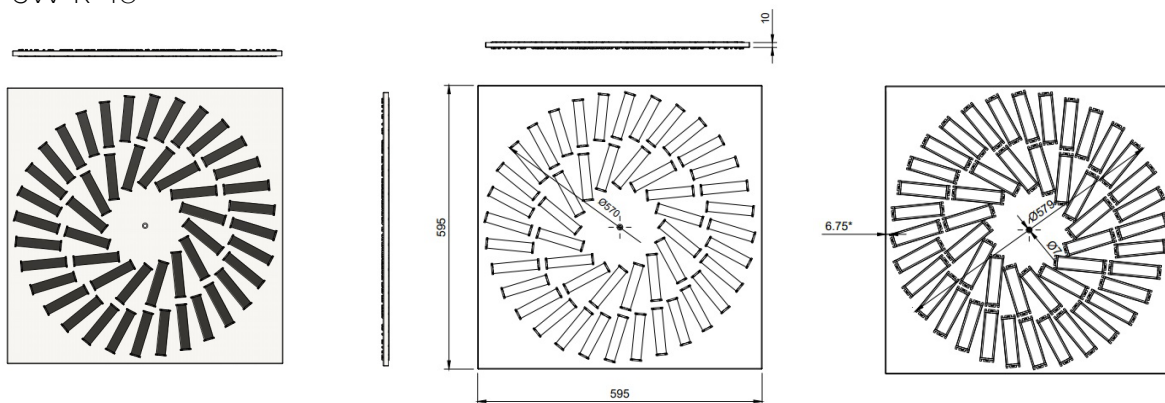

Product specifications

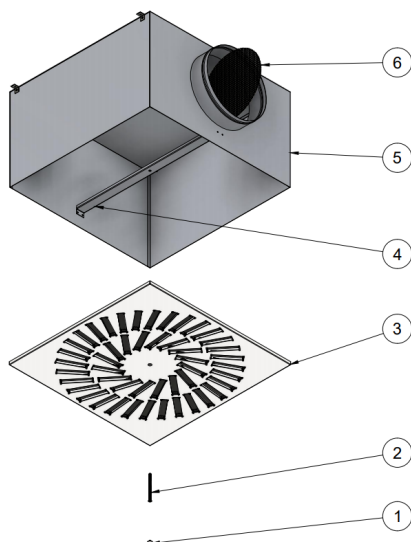

- 1 - Masking cap
- 2 - Fixing screw
- 3 - SW-R-48 diffuser
- 4 - Bracket (mounting crossbar)
- 5 - Plenum box (optional)
- 6 - Perforated damper (optional)

Accessories

The diffuser can be delivered with a connecting plenum to the circular duct, with horizontal or vertical connection. The plenum is provided with suspension elements (lugs) and bead roll on the spigot, for easy fixing of the flexible duct. Optionally, a perforated damper can be mounted on the plenum connection to balance the air flow.

Adapter (plenum box)

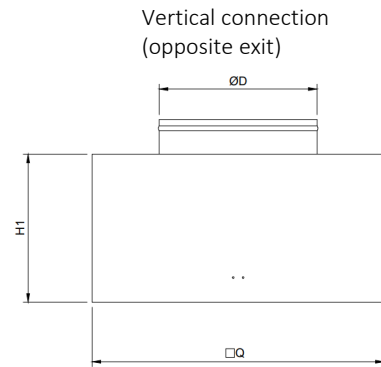
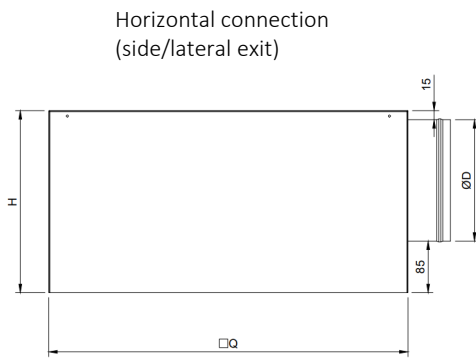

□Q: 590 x 590 mm
H – depending on ØD
H1 - on request

The adapter is made of Z140 galvanized steel sheet and has 4 suspension lugs.

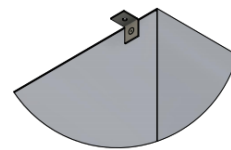
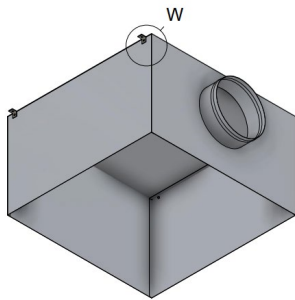

W - Suspension lug

On request, the plenum can be insulated with 6 mm thick elastomeric rubber.

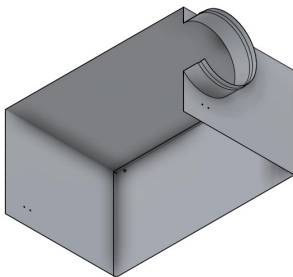

AN - Uninsulated adapter

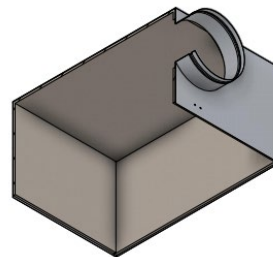

AIZ - Insulated adapter

Perforated damper

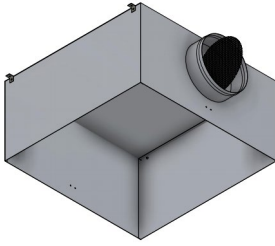

Position 0°

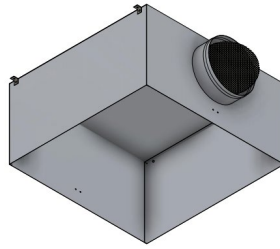

Position 45°

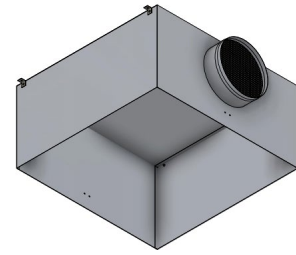

Position 90°

The perforated damper is mounted on the adapter spigot and has the role of balancing the air flow.

Functional parameters

SW-R-24

Air flow [m³/h]	L x H [mm]	595 x 595	
	Ak [m²]	0.0295	
	Role	Extraction	Supply
250	Veff[m/s]	2.35	2.4
	NR [dB(A)]	16.0	13.0
	ΔPt [Pa]	4.0	3.0
400	Veff[m/s]	3.77	3.8
	NR [dB(A)]	24.0	16.0
	ΔPt [Pa]	12.0	4.0
500	Veff[m/s]	4.71	4.7
	NR [dB(A)]	30.0	18.0
	ΔPt [Pa]	15.0	6.0
600	Veff[m/s]	5.65	5.6
	NR [dB(A)]	33.0	20.0
	ΔPt [Pa]	20.0	8.0
700	Veff[m/s]	6.59	6.6
	NR [dB(A)]	36.0	23.0
	ΔPt [Pa]	25.0	9.0
800	Veff[m/s]	7.53	7.5
	NR [dB(A)]	43.0	30.0
	ΔPt [Pa]	35.0	15.0
1000	Veff[m/s]		9.4
	NR [dB(A)]		35.0
	ΔPt [Pa]		20.0
1200	Veff[m/s]		11.3
	NR [dB(A)]		40.0
	ΔPt [Pa]		30.0

SW-R-48

Air flow [m³/h]	L x H [mm]	595 x 595	
	Ak [m²]	0.0390	
	Role	Extraction	Supply
350	Veff[m/s]	2.49	2.5
	NR [dB(A)]	20.0	15.0
	ΔPt [Pa]	6.0	3.0
400	Veff[m/s]	2.85	2.8
	NR [dB(A)]	23.0	16.0
	ΔPt [Pa]	12.0	4.0
500	Veff[m/s]	3.56	3.6
	NR [dB(A)]	27.0	18.0
	ΔPt [Pa]	14.0	5.0
600	Veff[m/s]	4.27	4.3
	NR [dB(A)]	30.0	20.0
	ΔPt [Pa]	17.0	6.0
700	Veff[m/s]	4.99	5.0
	NR [dB(A)]	33.0	23.0
	ΔPt [Pa]	20.0	7.5
800	Veff[m/s]	5.70	5.7
	NR [dB(A)]	36.0	25.0
	ΔPt [Pa]	28.0	8.0
1000	Veff[m/s]	7.12	7.1
	NR [dB(A)]	43.0	35.0
	ΔPt [Pa]	45.0	15.0
1400	Veff[m/s]		10.0
	NR [dB(A)]		45.0
	ΔPt [Pa]		30.0

The legend

Ak [m²] - The free surface

Veff [m/s] - The effective air velocity

NR [dB (A)] - Noise level without room attenuation

ΔPt [Pa] - Pressure loss

Installation

The diffuser can be mounted in 600 x 600 mm T-bar false ceiling, continuous ceiling or suspended.

The fixing of the plenum diffuser is done by using a central screw screwed into the mounting bracket, positioned inside of the plenum box.

Installation in T-bar suspended ceiling

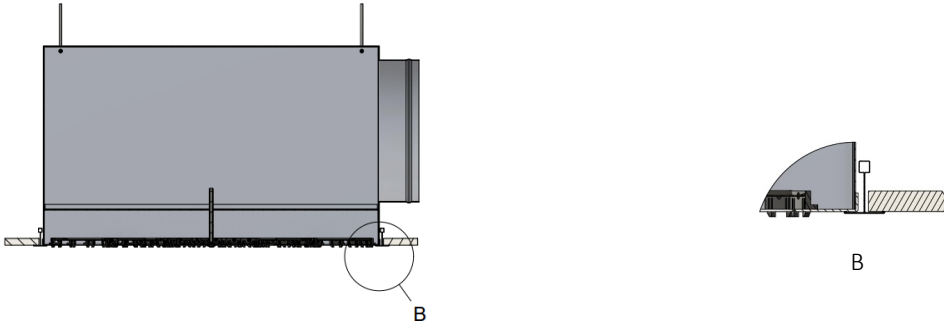

Installation in continuous ceiling

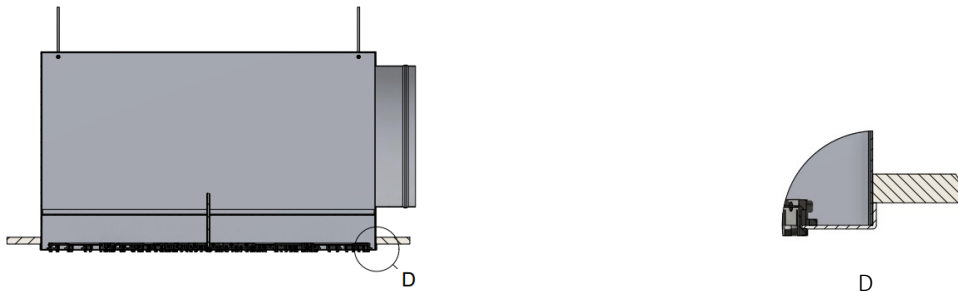

Suspended in the ceiling

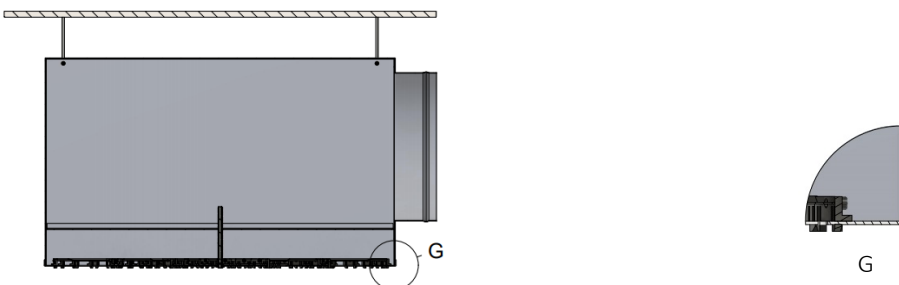

Order code

Example on how to place an order

Type	Slot number	Dimensions	Accessories	Finish
SW-R	24, 48 slots	595 x 595	AIZ - Insulated adapter AN - Uninsulated adapter Perforated damper (plenum box)	RAL9016 (black blades) RAL.. - Other RAL colors on request (black blades)