

Air through perfection

Decorative grille

LB

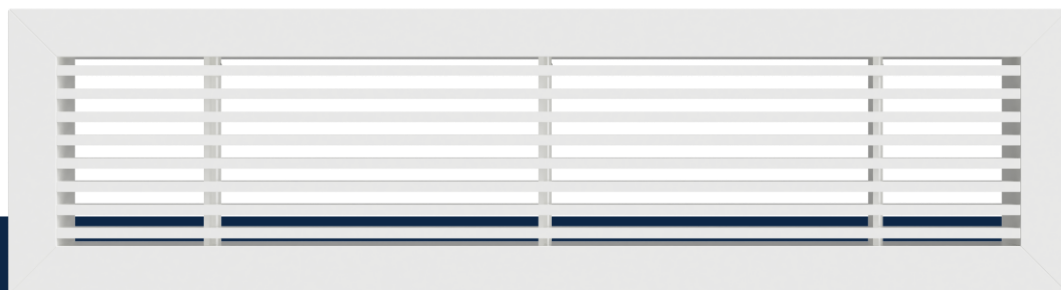

ACP
Decorative linear grilles

Decorative grille LB



Description

LB is a decorative linear aluminum grille used for introducing or evacuating air.

The grille is recommended for installations with constant or variable air flow.

LB can be applied to the ceiling or wall.

Technical specifications

Characteristics

The grille is available in two constructive variants:

LB-0 - with fixed blades at 0°

LB-15 - with fixed blades at 15°

The grille blades are fixed and parallel to the "L" (length).

For grilles with a length > 3m, the execution is modular, and the product is delivered together with the necessary connecting elements.

Depending on the overall position, the modular parts are built without termination elements or with a single element - see assembly sections.

As standard, the grille is manufactured with holes for screw mounting.

The product is delivered with fixing screws painted in the shade of the product.

Optionally, a mounting frame can be used for concealed mounting.

For installation with a mounting frame, the grille is accessorized with fixing clips.

Dimensional limits: Lint > 3m modular design, Hint max = 350 mm (standard).

Materials

The grille is made of extruded aluminum electrostatic field painted in glossy white RAL 9016.

On request, the grille can be made of natural anodized aluminum profiles or can be painted in other shades from the RAL palette.

Technical drawing

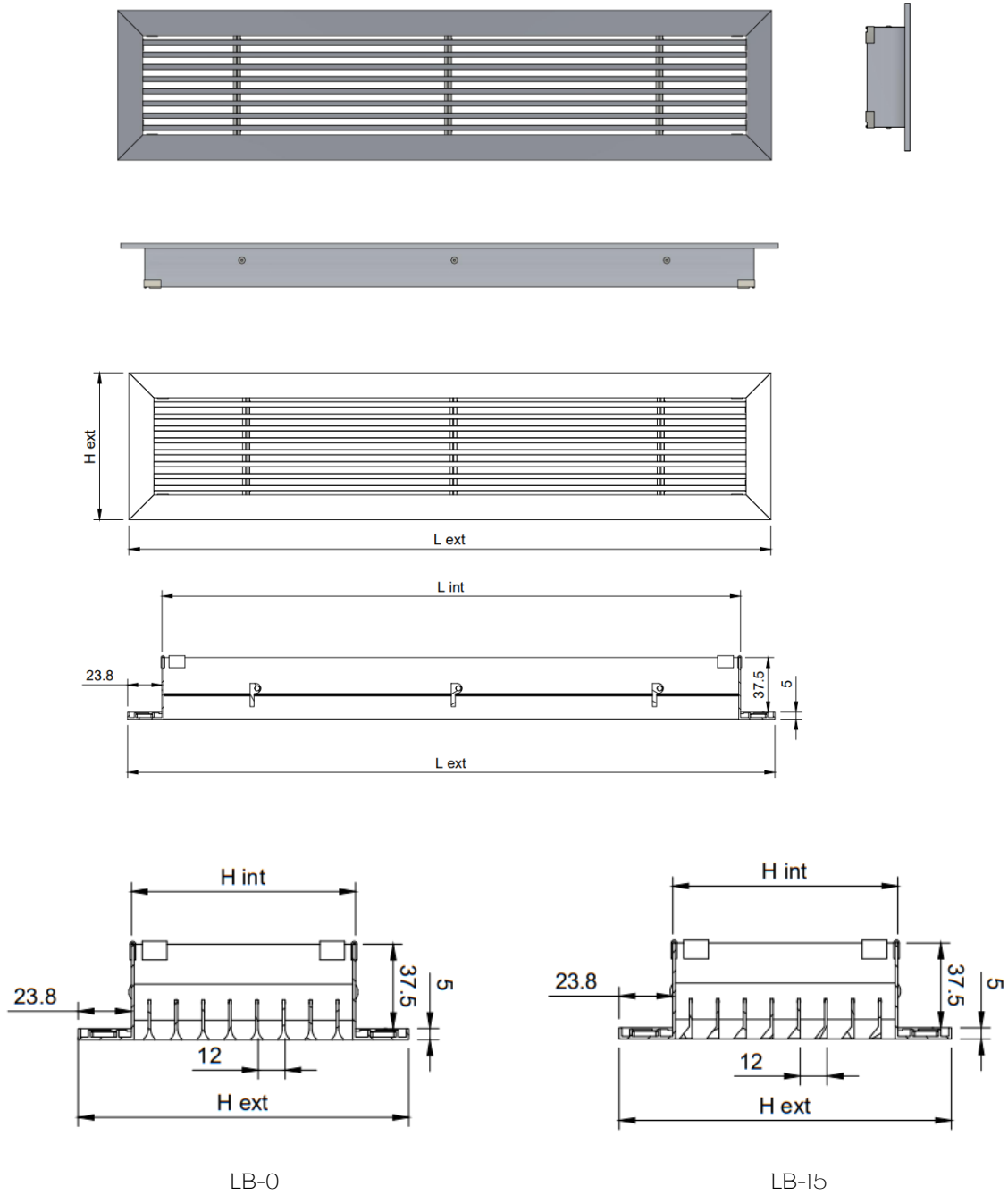

Product specifications

The grille is made standard with mounting holes positioned on the product frame. The number of holes and their position are made according to the size of the product, according to the pictures and table.

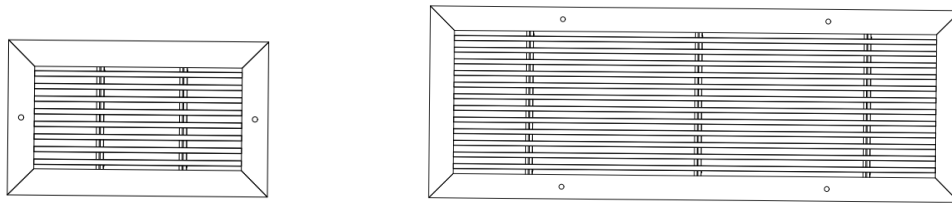

L x H [mm]	Number of holes													
	100	200	300	400	500	1000	1100	1200	1500	1600	2000	2100	2500	3000
85	2	2	4	4	4	4	4	6	6	6	8	8	8	8
100	2	2	4	4	4	4	4	6	6	6	8	8	8	8
150	2	2	4	4	4	4	4	6	6	6	8	8	8	8
200	2	2	4	4	4	4	4	6	6	6	8	8	8	8
300	4	4	4	4	4	4	4	6	6	6	6	8	8	8
350	4	4	4	4	4	4	4	6	6	6	6	8	8	8

Section assembly

Large length grilles are made of modules with a maximum length of 3 m. In this case the product is delivered with connecting elements between modules.

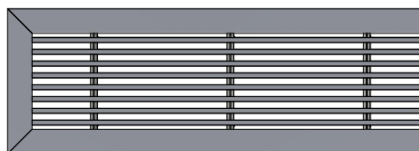
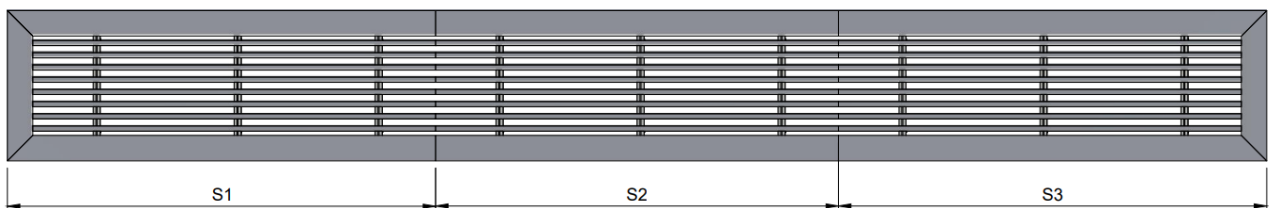

S1

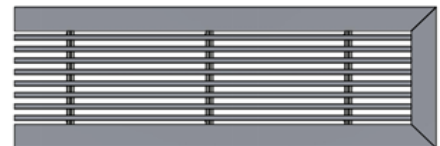

S3

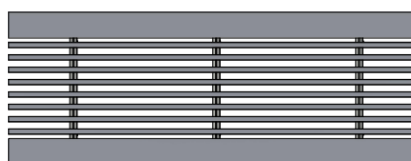

S2

Accessories

The grille can be delivered with a connecting plenum to the circular duct, with horizontal or vertical connection.

The plenum is provided with suspension elements (lugs) and bead roll on the spigot, for easy fixing of the flexible duct.

The product can also be accessorized with opposed blade damper, G4 air filter or mounting frame.

Adapter (plenum box)

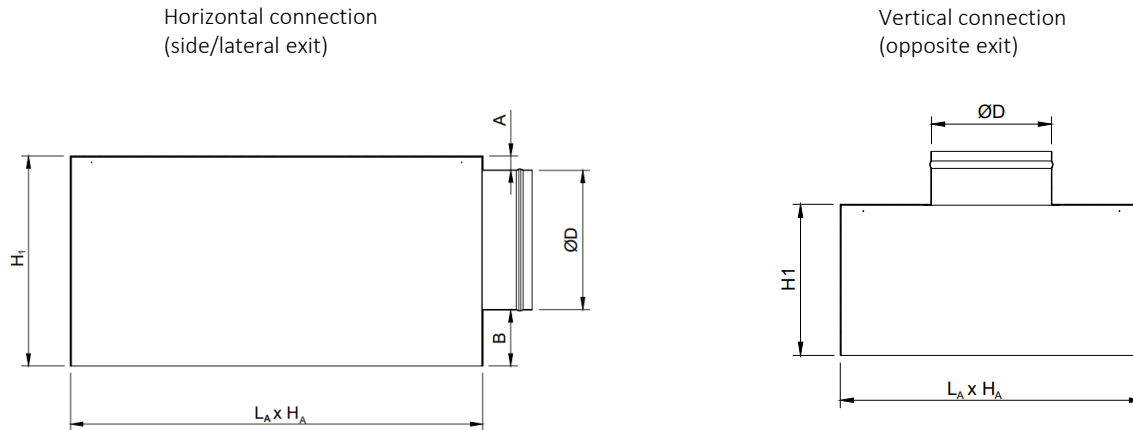

* For fixing with screws: $L_A \times H_A = L_{int} \times H_{int} \text{ grille} + 5 \text{ mm}$

* For fixing with mounting frame: $L_A \times H_A = L_c \times H_c \text{ mounting frame} + 3 \text{ mm}$

A, B, H_1 – depending on demand and $\varnothing D$

The adapter is made of Z140 galvanized steel sheet and is equipped with suspension lugs.

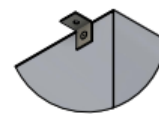
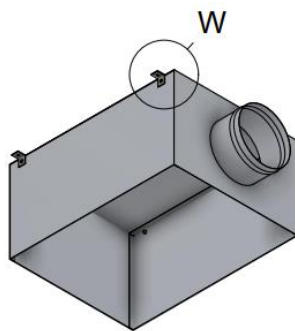

W - Suspension lug

The plenum is available in two options, uninsulated or insulated with 6 mm thick elastomeric rubber.

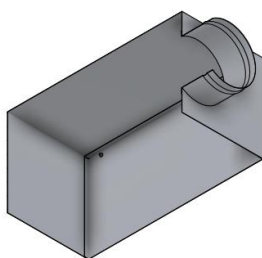

AN - Uninsulated adapter

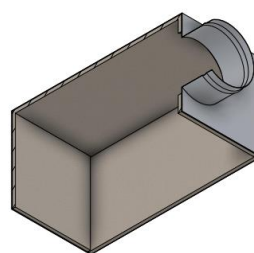

AIZ - Insulated adapter

Opposed blade damper (OBD)

The damper is provided with opposable blades and gears, it is mounted on the grille connection.

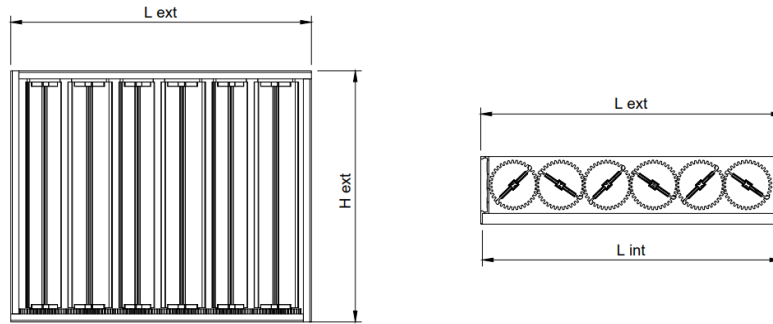

L x H [mm]	Opposed blade damper											
	100	500	600	700	1000	1200	1300	1800	1900	2400	2500	3000
85	1	1	1	2	2	2	3	3	4	4	5	5
100	1	1	1	2	2	2	3	3	4	4	5	5
150	1	1	1	2	2	2	3	3	4	4	5	5
200	1	1	1	2	2	2	3	3	4	4	5	5
300	1	1	1	2	2	2	3	3	4	4	5	5
350	1	1	1	2	2	2	3	3	4	4	5	5

Air filter G4 (F-R)

G4 air filter with aluminum frame is used for air filtration and is mounted on the grille connection.

The large dimensions are made in several pieces.

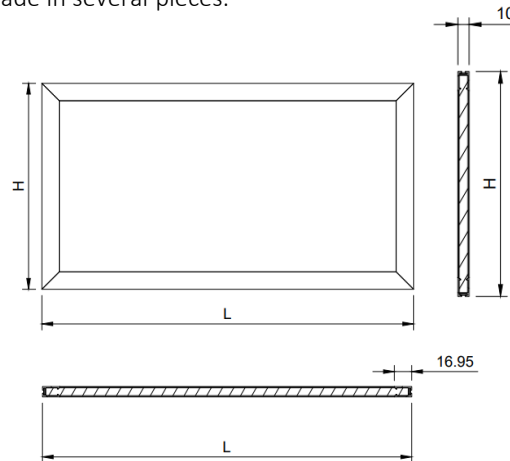

L x H [mm]	Air filter									
	100	500	1000	1100	1200	1500	2000	2100	2500	3000
85	1	1	1	1	2	2	2	3	3	3
100	1	1	1	1	2	2	2	3	3	3
150	1	1	1	1	2	2	2	3	3	3
200	1	1	1	1	2	2	2	3	3	3
300	1	1	1	1	2	2	2	3	3	3
350	1	1	1	1	2	2	2	3	3	3

Mounting frame (CC)

The mounting frame is used when a hidden, easy and fast mounting of the grille is desired. Depending on the size required, it is made and delivered in one or more pieces.

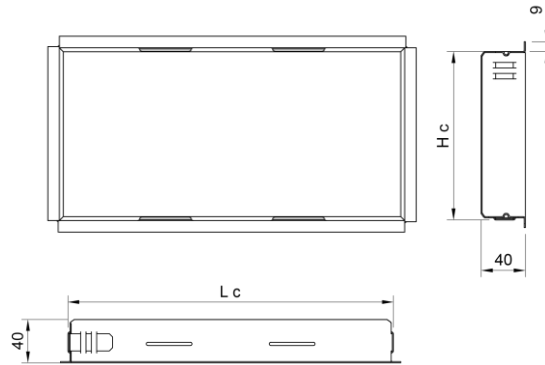

L x H [mm]	Mounting frame									
	100	500	1000	1100	1200	1500	2000	2100	2500	3000
85	1	1	1	1	2	2	2	3	3	3
100	1	1	1	1	2	2	2	3	3	3
150	1	1	1	1	2	2	2	3	3	3
200	1	1	1	1	2	2	2	3	3	3
300	1	1	1	1	2	2	2	3	3	3
350	1	1	1	1	2	2	2	3	3	3

For installation with mounting frame, the grille is equipped with clips that allow quick and easy clamping.

The number of mounting clips that the grille is equipped depends on the size of the product.

L x H [mm]	Number of mounting clips													
	100	200	300	400	500	1000	1100	1200	1500	1600	2000	2100	2500	3000
85	2	2	4	4	4	4	6	6	6	8	8	10	10	10
100	2	2	4	4	4	4	6	6	6	8	8	10	10	10
150	2	2	4	4	4	4	6	6	6	8	8	10	10	10
200	2	2	4	4	4	4	6	6	6	8	8	10	10	10
300	6	6	6	6	6	6	6	6	6	8	8	12	12	12
350	6	6	6	6	6	6	6	6	6	8	8	12	12	12

Example: LB-0 + CC

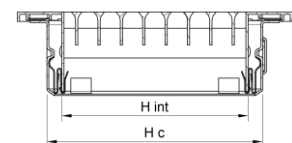
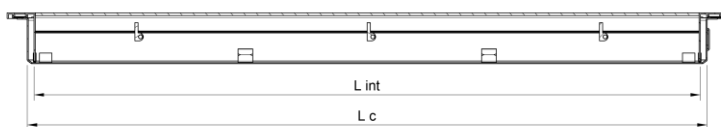

$$L_c \times H_c = L_{int} \times H_{int} \text{ grille} + 18 \text{ mm}$$

Functional parameters

Air flow [m ³ /h]	L x H [mm]	250x100	300x100	400x100	500x100	600x100	800x100	1000x100	1500x100	400x150	600x150	1000x150	600x200	800x200	1000x200
	Ak [m ²]	0.011	0.013	0.019	0.024	0.029	0.041	0.05	0.075	0.033	0.045	0.081	0.064	0.085	0.12
140	X [m]	3.0													
	NR [dB(A)]	<20													
	ΔPt [Pa]	6.0													
	Veff [m/s]	3.2													
200	X [m]	4.2	3.8	3.2											
	NR [dB(A)]	25.0	21.0	<20											
	ΔPt [Pa]	10.0	10.0	5.0											
	Veff [m/s]	4.6	4.0	2.8											
300	X [m]	6.3	5.8	5.0	4.3										
	NR [dB(A)]	35.0	30.0	24.0	18.0										
	ΔPt [Pa]	30.0	18.0	10.0	7.0										
	Veff [m/s]	6.9	6.0	4.2	3.3										
400	X [m]	8.5	7.8	6.5	5.8	5.3	4.6			5.1					
	NR [dB(A)]	43.0	38.0	32.0	25.0	22.0	<20			25					
	ΔPt [Pa]	50.0	35.0	18.0	10.0	9.0	5			8					
	Veff [m/s]	9.3	7.9	5.6	4.4	3.8	2.6			3.4					
600	X [m]	12.0	11.5	10.0	8.7	6.0	7	6		8	6.3				
	NR [dB(A)]	53.0	48.0	42.0	35.0	33.0	26	25		35	25				
	ΔPt [Pa]	118.0	80.0	40.0	30.0	20.0	12	7		16	8				
	Veff [m/s]	13.9	11.9	8.3	6.7	5.7	4.0	3.1		5.1	3.7				
800	X [m]			15.0	12.0	10.5	9.3	8.5	6.5	11	8.5	6.8	7		
	NR [dB(A)]			51.0	45.0	45.0	33	32	20	42	30	21	25		
	ΔPt [Pa]			75.0	48.0	35.0	20	15	6	32	15	5	8		
	Veff [m/s]			11.1	8.9	7.7	5.3	4.2	3.2	6.7	4.9	2.7	3.5		
1000	X [m]					13.0	11	10.2	8.3	13	11	8	9	7.8	7
	NR [dB(A)]					45.0	42	37	28	46	38	27	30	25	<20
	ΔPt [Pa]					55.0	30	20	9	48	22	8	12	8	3
	Veff [m/s]					9.6	6.6	5.2	4.0	8.4	6.2	3.3	4.3	3.3	2.3
1400	X [m]						16.5	14	12		15	12	12	11	11
	NR [dB(A)]						50	45	37		48	35	40	33	33
	ΔPt [Pa]						55	37	18		40	15	22	12	12
	Veff [m/s]						9.3	7.3	5.6		8.6	4.7	6.1	4.6	3.2
2000	X [m]											16	18	15	14
	NR [dB(A)]											45	50	43	35
	ΔPt [Pa]											30	42	25	17
	Veff [m/s]											6.7	8.7	6.5	4.6
2500	X [m]											21		20	18
	NR [dB(A)]											50		48	45
	ΔPt [Pa]											45		37	25
	Veff [m/s]											8.4		8.2	5.8
3000	X [m]														21
	NR [dB(A)]														48
	ΔPt [Pa]														35
	Veff [m/s]														6.9

The legend

Ak [m²] - The free surface

X [m] - The length of the air jet at a speed of 0.2 m/s

NR [dB (A)] - Noise level without room attenuation

ΔPt [Pa] - Pressure loss

Veff [m/s] – Air velocity in the grille

Installation

As standard, the grille is mounted by screws.

Optionally, for a hidden and easy assembly, a mounting frame can be used. The installation of the grille in the mounting frame is done by clamping.

Wall/ceiling mounting with screws

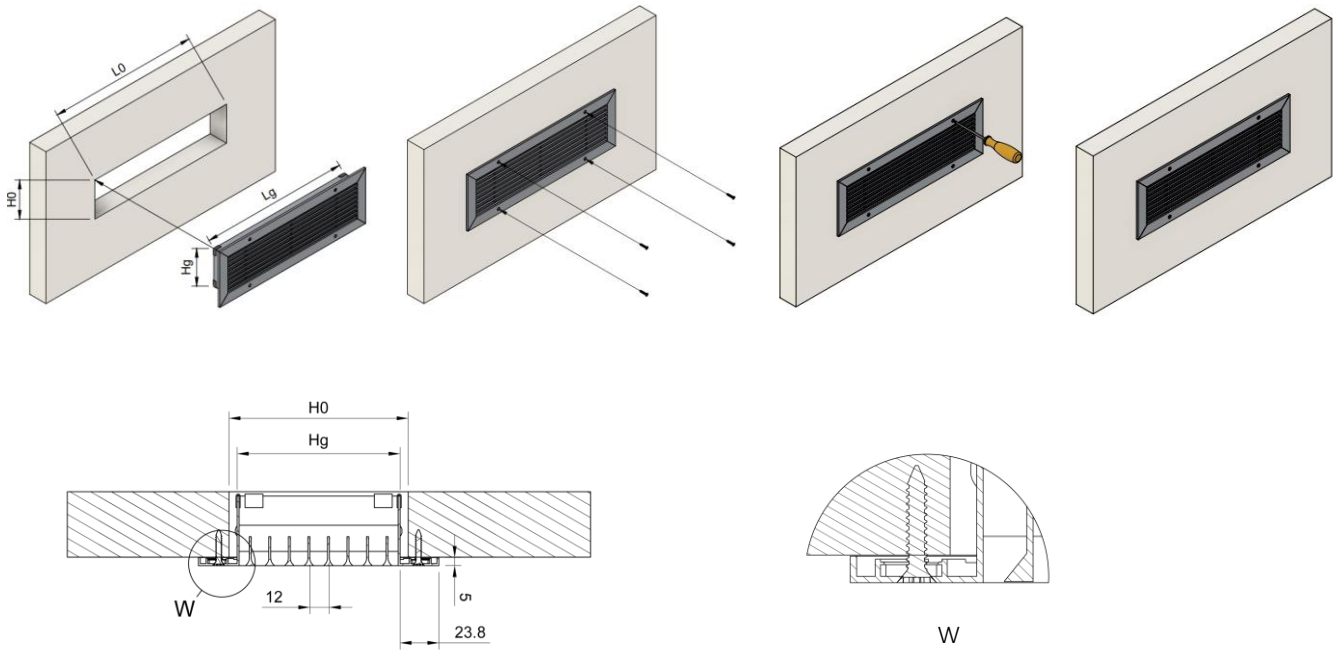

Wall/ceiling installation with mounting frame

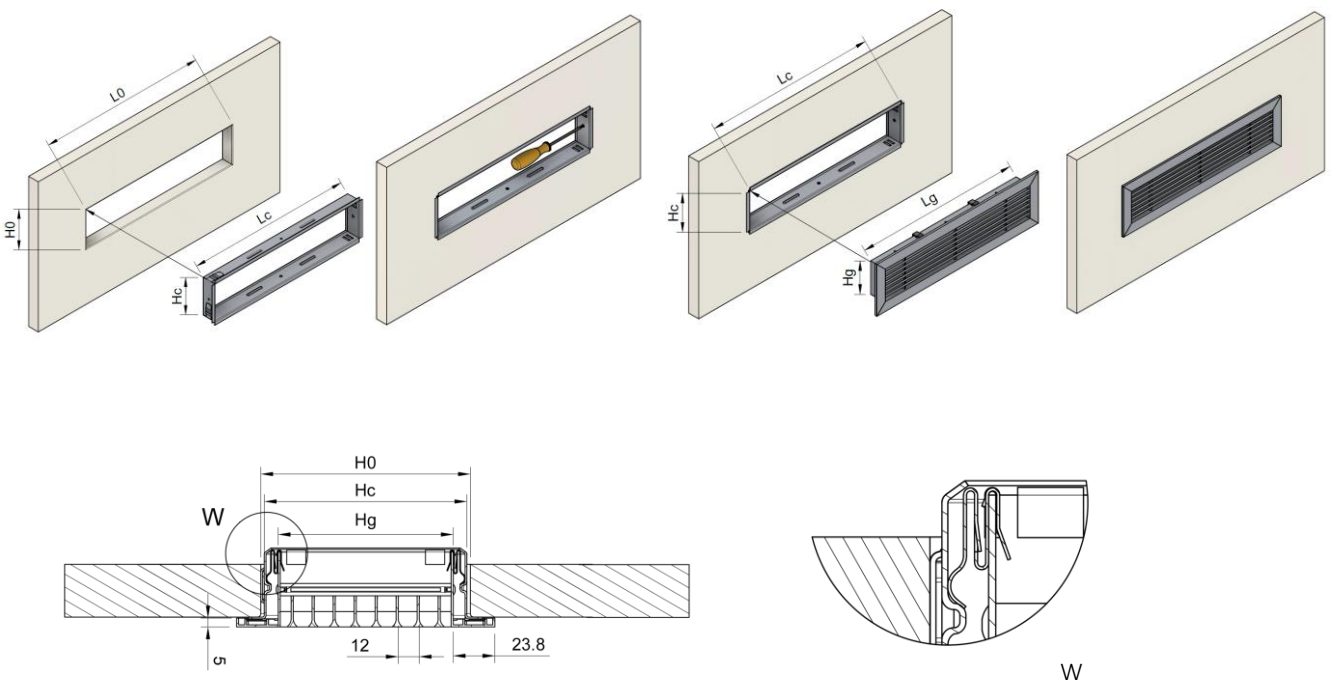

Order code

Example on how to place an order

Type	Dimensions	Section	Accessories	Mounting	Finish
LB-0					
LB-15					
On request					
S1 -Left end section					
S2 - Middle section					
S3 - Right end section					
F-R - Air filter G4					
OBD - Control damper					
AIZ - Insulated adapter					
AN - Uninsulated adapter					
Screws (standard)					
CC - Mounting frame (optional)					
RAL9016					
RAL.. - Other RAL colors on request					
EL - Natural anodized					