

Air through perfection

# Ceiling diffuser 1-way

## CD-1

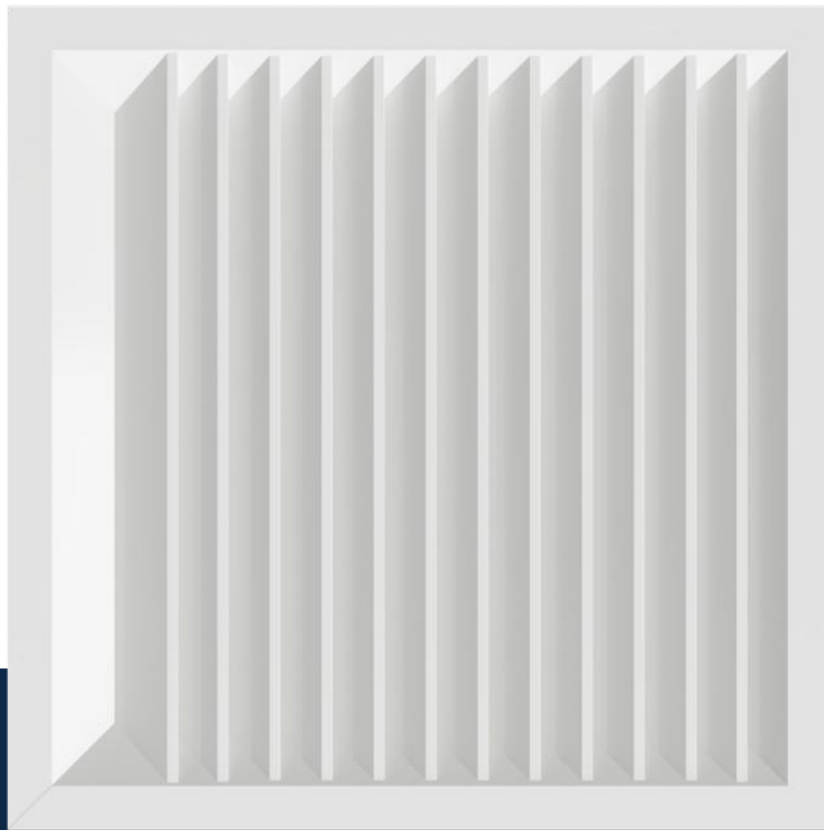

**ACP**  
Ceiling diffusers

## Ceiling diffuser 1-way CD-1



### Description

Square ceiling diffuser with slides positioned in one direction, made of aluminum, used for air supply or exhaust.

The ceiling diffuser can be used in installations with constant or variable air flow and is intended for spaces with a height <4m.

Used for ceiling mounting.

### Technical specifications

#### Characteristics

Allows the air to discharge horizontally at the ceiling level.

The central part is removable which facilitates mounting.

Airflow adjustment can be achieved by mounting an opposed blade damper (OBD) on the diffuser connection.

Diffuser installation is easy.

#### Materials

The diffuser is made of aluminum and is electrostatic field painted in glossy white RAL9016.

Other RAL colours are available on request.

Technical drawing

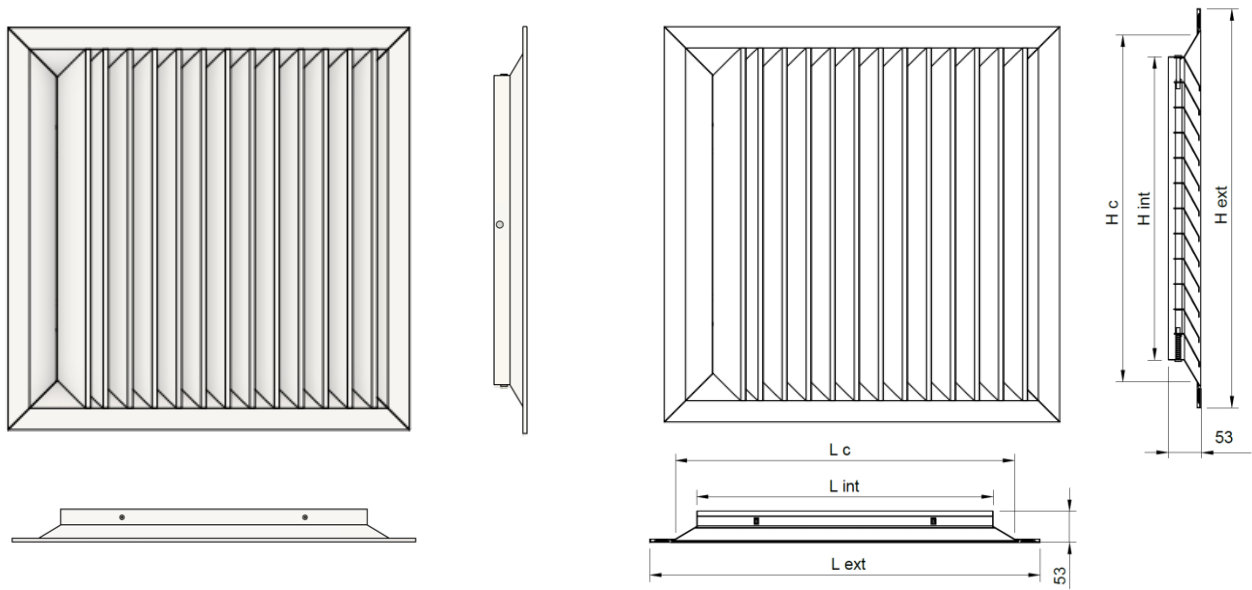

Int / Ext [mm]	Lint x Hint [mm]	Lext x Hext [mm]	Lc x Hc [mm]
445/595	445 x 445	595 x 595	519 x 519

Product specifications

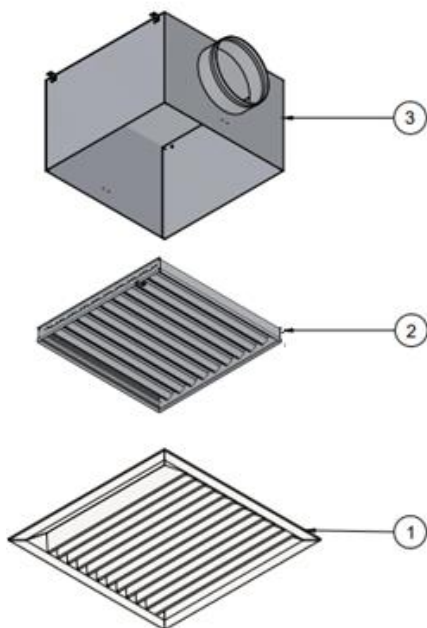

- 1- CD-1 Ceiling diffuser
- 2- OBD Opposed blade damper(optional)
- 3- Plenum box (optional)

## Accessories

The diffuser can be delivered with a connecting plenum to the circular duct, with horizontal or vertical connection. The plenum is provided with suspension elements (lugs) and bead roll on the spigot, for easy fixing of the flexible duct.

The product can be accessorized with opposed blade damper or G4 air filter.

### Adapter (plenum box)

Horizontal connection  
(side/lateral exit)

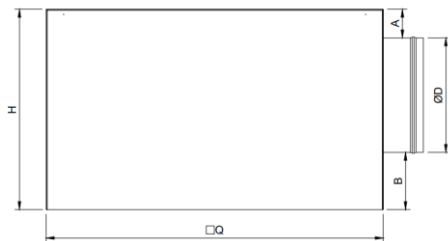

Vertical connection  
(opposite exit)

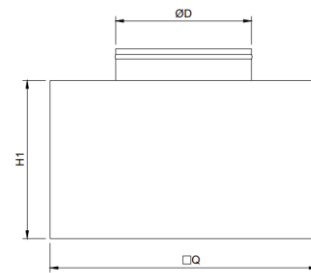

Q – depending on the size of the ceiling diffuser Lint x Hint  
A, B, H1, ØD – on request  
H – depending on A, B and ØD

The adapter is made of Z140 galvanized steel sheet and has 4 suspension lugs.

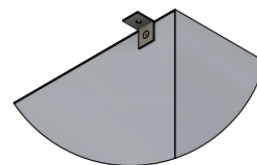
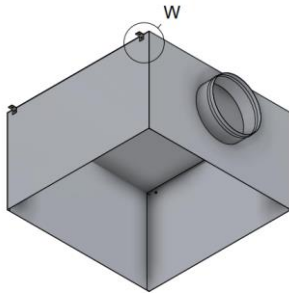

W - Suspension lug

On request, the plenum can be insulated with 6 mm thick elastomeric rubber.

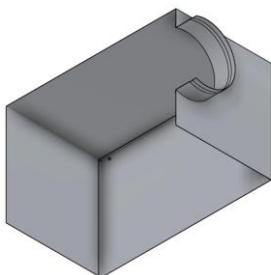

AN - Uninsulated adapter

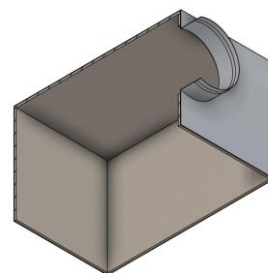

AIZ - Insulated adapter

Opposed blade damper (OBD)

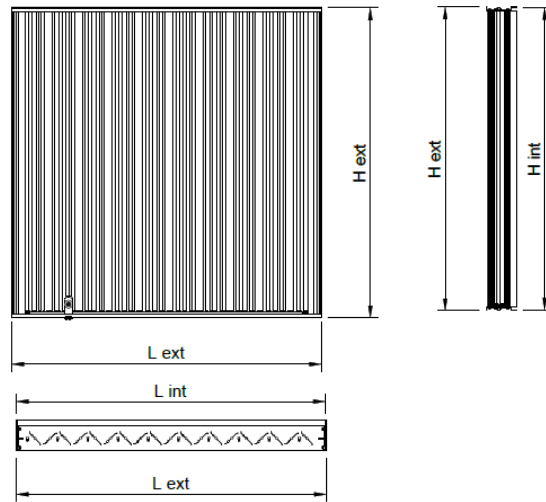

The damper is equipped with opposable blades and is mounted on the ceiling diffuser connection for adjusting the air flow.

Example: CD-1 + OBD

- 1- Ceiling diffuser CD-1
- 2- Opposed blade damper OBD

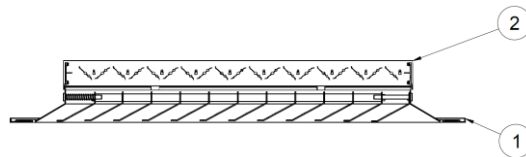

Air filter G4 (F-R)

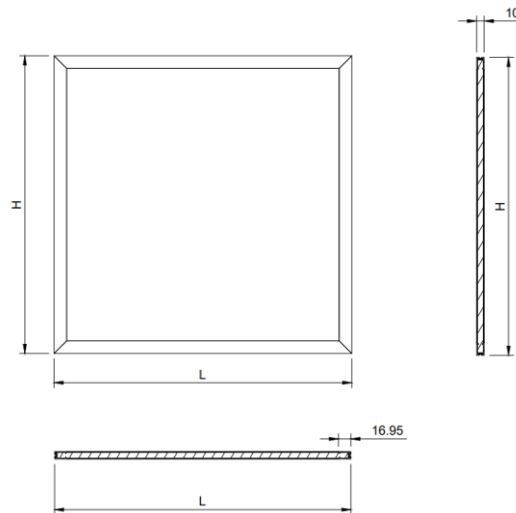

G4 air filter with frame, made of aluminum, used for air filtration and mounting on the ceiling diffuser connection.

Example : CD-1 + F-R

- 1- Ceiling diffuser CD-1
- 2- Air filter F-R

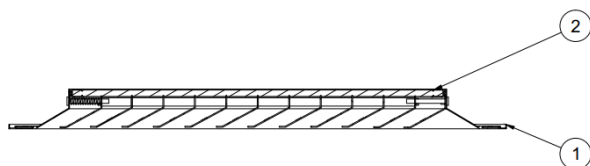

## Functional parameters

LxH int [mm]	Ak [m <sup>2</sup> ]	Air Flow [mc/h]	600	800	1000	1200	1600	2000
445 x 445	0.0863	Veff [m/s]	1.9	2.6	3.2	3.9	5.1	6.4
		X [m]	4.4	5.8	7.3	8.8	11.7	14.6
		NR [dB(A)]	20	27	33	37	44	50
		ΔPt [Pa]	2.6	4.6	7.3	10.4	18.6	29

The legend

Ak [m<sup>2</sup>] - The fre surface

Veff [m/s] - The effective air velocity

X [m] - The length of the air jet at a speed of 0.25 m/s

NR [dB (A)] - Noise level without room attenuation

ΔPt [Pa] - Pressure loss

## Installation

The ceiling diffuser can be mounted in a false suspended ceiling or a continuous ceiling.

### Installation in T-bar suspended ceiling

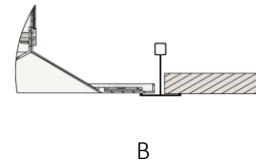
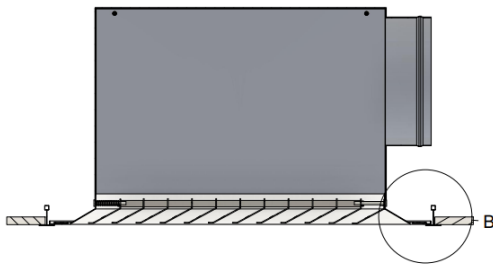

### Installation in continuous ceiling

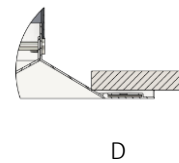
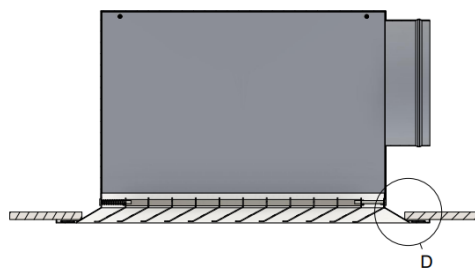

## Order code

Example on how to place an order

Type	Dimensions	Accessories	Finish
CD-1	445/595 - int/ext		
<b>OBD</b> - Control register <b>F-R</b> - Air filter G4 <b>AIZ</b> - Insulated adapter <b>AN</b> - Uninsulated adapter <b>RAL9016</b> <b>RAL..</b> - Other RAL colors on request			