

Air through perfection

Plenum box

AN & A12

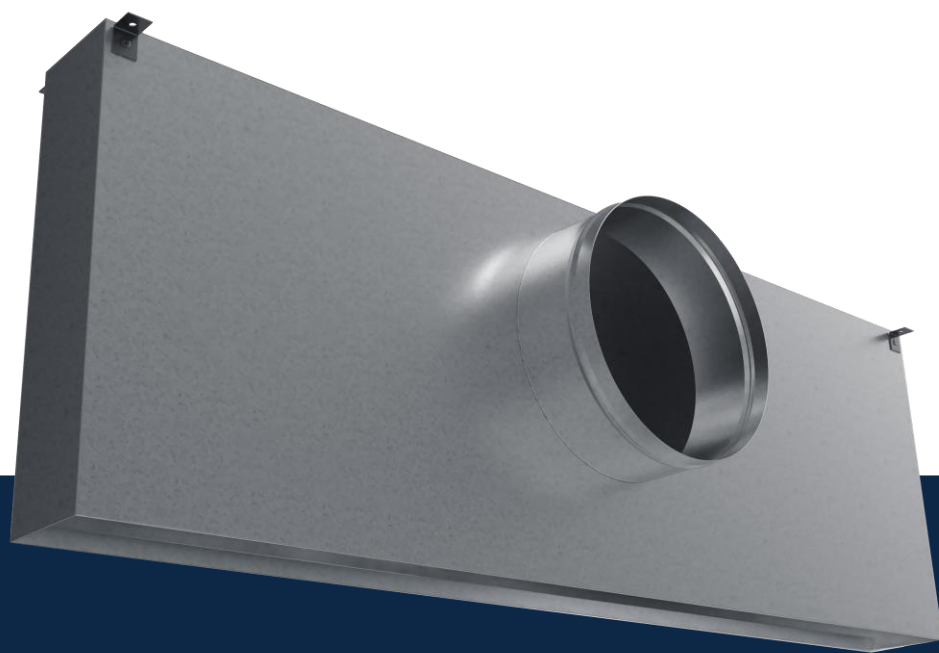

ACP
Plenum

www.acp.ro

Plenum box AN & AIZ

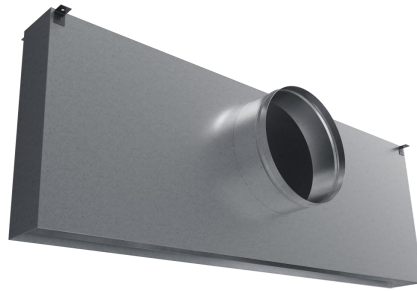

Description

Adapter (plenum box) made of Z140 galvanized steel sheet as a mixing element, air distribution and connection between the grille/diffuser and the duct.

The plenum is designed to distribute and balance airflow before diffusion, through the terminals (grilles and diffuser). Depending on the functional role, it can be insulated (AIZ) or uninsulated (AN).

Technical specifications

Characteristics

The adapter is made with one or more connections (spigots) for connection to the duct.

The spigot is positioned opposite the grille (vertical connection) or sideways (horizontal connection), according to the drawings.

The adapter is insulated inside. On request, the insulation can be placed on the outside of the plenum.

The plenum is provided with suspension elements (lugs) and bead roll on the spigot, for easy fixing of the flexible duct.

Technical drawing

Constructive variants

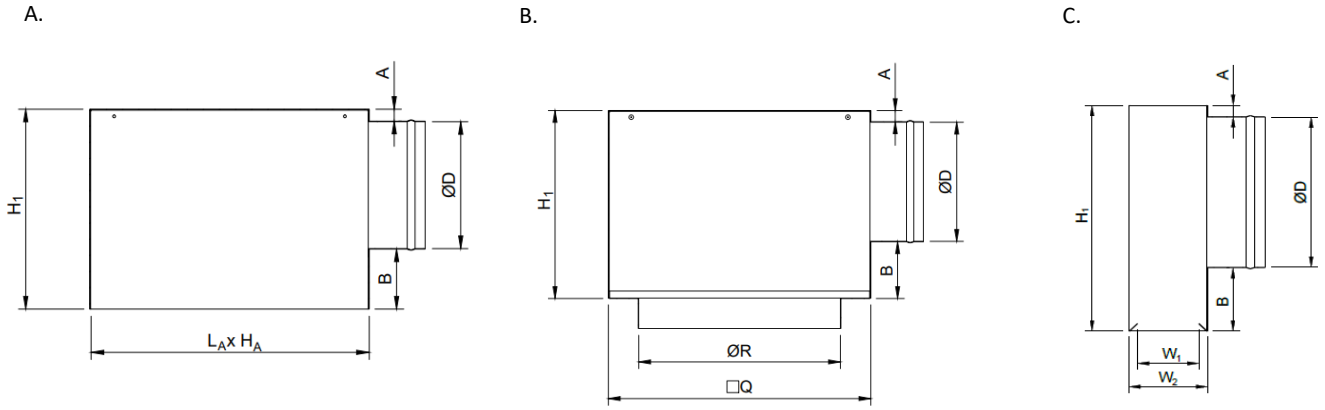

A – Plenum model for rectangular or square grilles/diffusers
 B – Plenum model for circular grilles/diffusers
 C – Plenum model for linear diffusers

$L_A \times H_A, \varnothing R, \square Q, W_1, W_2$ – depending on grille or diffuser size
 A, H1, $\varnothing D$ – according on the request
 B – depending on the depth of the grille/diffuser and the request

In the case of long linear diffusers, the plenum -Model C- is delivered in several sections

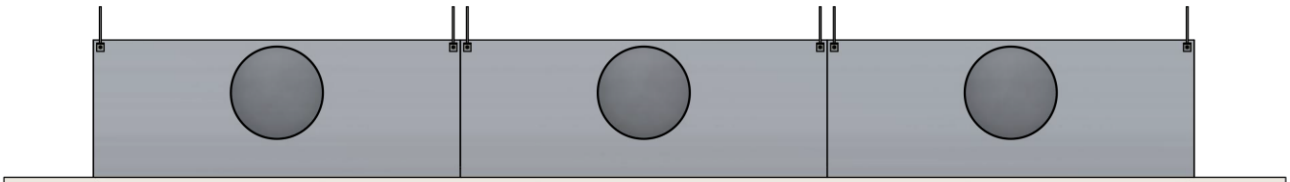

The plenum model A can be made, on request, with a seating flange. Flange size (F) is made according to the request ex. 10, 15, 20 mm.

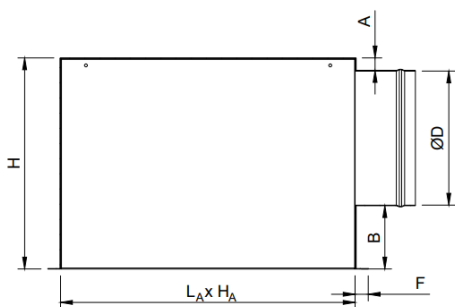

On request, plenums can be made with 1,2,3 or more connection for circular duct.

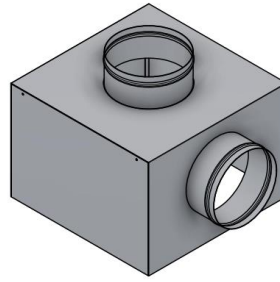
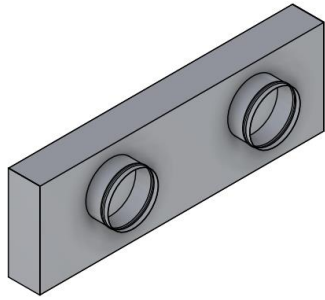

The plenums are equipped, as standard, with suspension lugs.

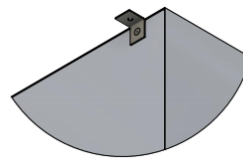
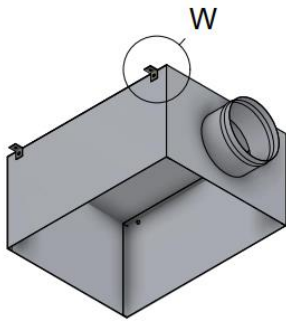

W - Suspension lug

Vertical or horizontal connection

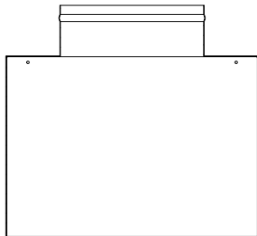

Vertical connection
(opposite exit)

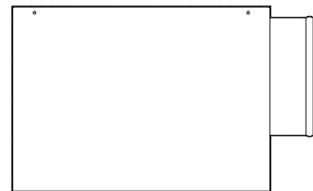

Horizontal connection
(side/lateral exit)

Uninsulated and insulated plenums

The material used to insulate the plenums is made of elastomeric rubber with a thickness of 6 mm.

The insulation is positioned, as standard, on the inside of the plenum. On request, it can be positioned on the outside.

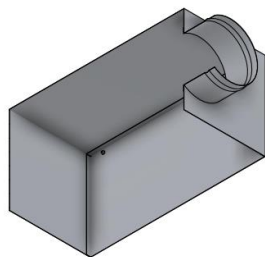

AN - Uninsulated plenum box

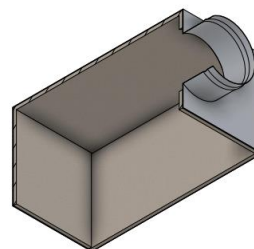

AIZ - Insulated plenum box

Materials

The product is made of galvanized steel sheet with zinc coating Z-140 g/m².

The thickness of the metal sheet is 0.6 mm (standard) and can vary between 0.6 - 1 mm depending on the request or the dimensions of the plenum.

The insulation of the AIZ adapter is made by applying an elastomeric rubber with a thickness of 6 mm.

Accessories

Perforated damper

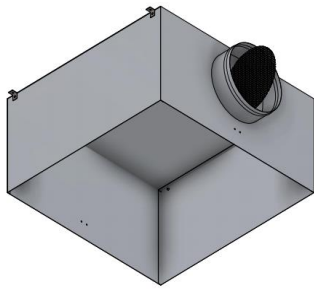

Position 0°

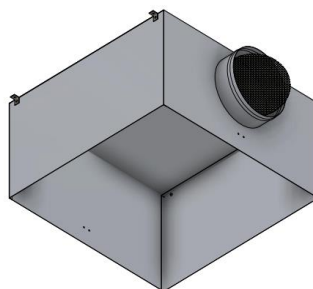

Position 45°

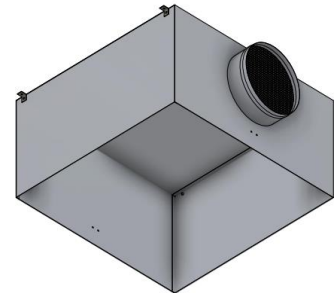

Position 90°

The perforated damper is mounted on the adapter nozzle and has the role of balancing the air flow.

Control damper



RD-G – Shut-off damper



RD-S – Shut-off damper for actuator

The manually or electrically operated control damper (with servomotor) can be mounted on the plenum box connection.

Bracket ("U" system)

The bracket is used for mounting/fixing the plenum diffusor.

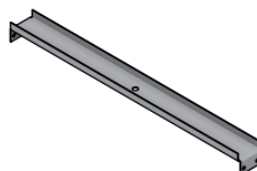

Installation

The fixing of the plenum in the ceiling is done with the help of the suspension elements (lugs).

Suspended in the ceiling

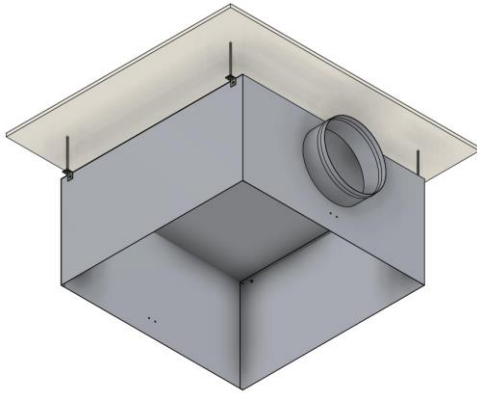

AN

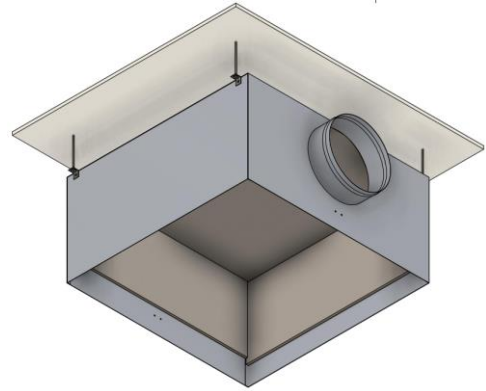

AIZ

Ex. Plenum mounting with ST diffusor in suspended grid ceiling

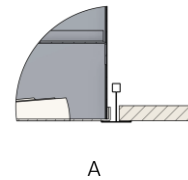
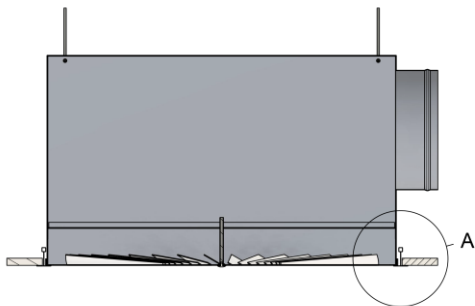

Order code

Example on how to place an order

	Type	Dimensions	Spigot	Accessories
AIZ	Type	Dimensions	Spigot	Accessories
AN				
On request				
1 (Number of outputs) x Ø...				
Perforated damper				
RD-G - Shut-off damper				
RD-S - Shut-off damper for actuator				
Bracket				